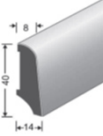

Detail Preisliste (exkl. MwSt.)

07/22

27/1

Öko-Holzsockel furniert

Holzarten	Profil konisch 40/14/8 mm Standardlänge 4.00 m 10 Stück pro Bund	lackiert Preis/m ¹	geölt Preis/m ¹
Eiche, Buche gedämpft, Buche ungedämpft, Ahorn		4.00	5.10
Nussbaum amerikanisch		4.30	---
weiss deckend RAL 9010 / RAL 9003 / RAL 9016		4.60	---
Auf Bestellung:			
Kirschbaum		4.30	---

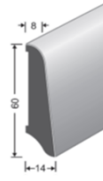
Holzarten	Profil konisch 60/14/8 mm Standardlänge 4.00 m 10 Stück pro Bund	lackiert Preis/m ¹	lackiert Preis/m ¹	geölt Preis/m ¹
		Sonderlänge 2.40 m		
Eiche		4.20	4.20	5.30
Buche gedämpft		4.10	4.10	5.20
Buche ungedämpft, Ahorn		4.10	4.10	---
Nussbaum amerikanisch		4.60	4.60	5.60
Kirschbaum		4.60	4.60	---
Kiefer*, Birke*, Esche, Erle*, Kork natur		---	4.60	---
Esche weiss lasiert, Esche crème lasiert*		---	5.00	---
weiss deckend RAL 9010 / RAL 9003 / RAL 9016		5.00	5.00	---
Auf Bestellung:				
Lärche			4.60	---
Esche, Birnbaum/Elsbeer, Ulme (leicht gedämpft)		4.60	---	
Eichen Optik (18 Farbtöne gemäss Musterfächer)		6.20	---	

Holzarten	Profil konisch 70/14/8 mm Standardlänge 4.00 m 10 Stück pro Bund	lackiert Preis/m ¹
Eiche		6.40
Buche gedämpft		6.20
weiss deckend RAL 9003 / RAL 9010 / RAL 9016		7.10
kein Montagezubehör lieferbar!		

Holzarten	Profil konisch 60/22/8 mm Standardlänge 4.00 m 10 Stück pro Bund	lackiert Preis/m ¹
Eiche		5.40
Buche gedämpft, Ahorn		5.30
weiss deckend RAL 9010		5.80

Montagezubehör		Aussenecken Preis/Stk.	Innenecken Preis/Stk.	Endstücke Li / Re Preis/Stk.
Montagezubehör 14/8	* = kein Montagezubehör erhältlich	2.10	2.10	1.75
Montagezubehör 22/8	> Abverkauf, nur solange Vorrat	1.75	1.75	1.45

Detail Preisliste (exkl. MwSt.)

07/22

27/2

Öko-Holzsockel furniert

Holzarten	Profil parallel 40/12 mm Standardlänge 4.00 m 10 Stück pro Bund	lackiert Preis/m ¹
-----------	--	----------------------------------

Eiche
 weiss deckend RAL 9010 / RAL 9003 / RAL 9016

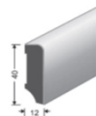

4.20
5.10

Holzarten	Profil parallel 60/12 mm Standardlänge 4.00 m 10 Stück pro Bund	lackiert Preis/m ¹
-----------	--	----------------------------------

Eiche
 weiss deckend RAL 9010 / RAL 9003 / RAL 9016

4.50
5.50

Holzarten	Profil parallel 80/12 mm Standardlänge 4.00 m 10 Stück pro Bund	lackiert Preis/m ¹
-----------	--	----------------------------------

Eiche
 weiss deckend RAL 9010 / RAL 9003 / RAL 9016

7.20
 8.00

Spezialitätensockel furniert

Holzarten	Profil konisch 60/14/8 mm Standardlänge 4.00 m 10 Stück pro Bund	ummantelt Preis/m ¹	lackiert Preis/m ¹
-----------	---	-----------------------------------	----------------------------------

Aluminium ummantelt
 Jatoba, Mahagoni
 Aframosia, Akazie gedämpft, Doussie
 Merbau, Wenge
 Bambus hell, Bambus dunkel
 Kork natur
 Kork crème lasiert

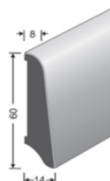

Sonderlänge 2.50 m
9.90

6.10
 6.30
 6.30
 7.70
 6.10
 7.50

Kunststoff-Sockel

Dekor	Profil konisch 60/14/8 mm Standardlänge 4.00 m 10 Stück pro Bund	Preis/m ¹
-------	---	----------------------

Eiche, Buche gedämpft, Ahorn, Weiss deckend (ähnlich RAL 9010)

4.10

Auf Bestellung (folienummantelt):

Artemis, Dionysos, Eros, Ganymedes, Iris, Megaira, Rhea, Zeus
 Eiche Morpheus (Räuchereiche)

4.30
 4.80

Massivholz Sockelleisten

Sockelleisten Ramin

Holzarten	Profil konisch 60/12/8 mm	solange Vorrat
	Längen zwischen 2.50 und 4.00 m	lackiert Preis/m ¹
Ramin	roh	4.30
Ramin	natur lackiert	4.90
Koto	natur lackiert	5.70
Koto	Eichenton	5.60
Koto	Nusston	6.40
Koto	weiss deckend RAL 9003	7.40
Koto	weiss deckend RAL 9010	7.40
Koto	seidengrau deckend RAL 7044	7.70
Koto	cremeweiss deckend RAL 9001	7.70
Koto	schwarz deckend RAL 9017	7.70

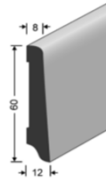

Sockelleisten massiv

Holzarten	Profil konisch 60/14/8 mm	lackiert	geölt
	Längen zwischen 2.00 und 4.00 m	Preis/m ¹	Preis/m ¹
Buche gedämpft		7.00	8.20
Buche ungedämpft		7.00	8.20
Ahorn europäisch		10.10	11.30
Eiche europäisch		13.10	13.80
Esche		7.50	8.70
Fichte		7.00	8.20
Lärche		10.10	---

Holzarten	Profil konisch 80/15/10 mm	lackiert
	Längen zwischen 2.50 und 4.00 m	Preis/m ¹
Buche gedämpft		12.60
Buche ungedämpft		13.10
Ahorn kanadisch		20.00
Eiche europäisch		17.70

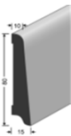

Detail Preisliste (exkl. MwSt.)

07/22

27/4

Schwellenleisten massiv; natur-/farblackiert

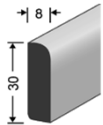
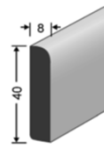
Holzarten	Längen zwischen 2.50 und 4.00 m	pro Bund zwischen 35 - 45 m ¹	solange Vorrat	
			30/8 Preis/m ¹	40/8 Preis/m ¹
Buche gedämpft			3.70	4.80
Buche ungedämpft			3.90	5.00
Eiche			5.30	6.70
Ahorn kanadisch			5.90	8.30
Ramin Weiss deckend	RAL 9003		4.00	
Koto Weiss deckend	RAL 9003		4.60	5.90
Tanne			3.90	--

Limattaler Sockel

Holzarten	fallende Längen	pro Bund ca. 18 m ¹	80/12	100/12
			Preis/m ¹	Preis/m ¹
Poplar	Weiss deckend RAL 9003		15.60	20.00
Poplar	Weiss deckend RAL 9010		15.60	20.00
Poplar	Weiss deckend RAL 9016		15.60	20.00

Lignoform-Kabelsockel inkl. Grundleiste

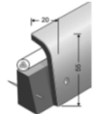
Holzarten	Profil 55/20 mm		lackiert		
	Standardlänge 4.00 m	8 Stück pro Bund	Preis/m ¹		
Eiche			5.50		
Buche gedämpft			5.50		
Ahorn kanadisch (solange Vorrat)			6.30		
Weiss deckend			6.70		
Montagezubehör			Aussenecken	Innenecken	Endstücke Li / Re
			Preis/Stk.	Preis/Stk.	Preis/Stk.
Montagezubehör Lignoform-Kabelsockel			2.20	2.20	1.80

Meister-Sockelleisten

siehe Meister-Preisliste



Detail Preisliste (exkl. MwSt.)

07/22

27/5

Alu Sockelleisten

Alu-Sockel mit Fuss

Materialart	Profil Standardlänge 4.00 m	6 Stück pro Bund	ungelocht	gelocht
			Preis/m ¹	Preis/m ¹
Silber eloxiert	40/10		5.80	7.10
Hellbronze eloxiert	40/10		9.60	10.90
Weiss RAL 9003	40/10		9.10	10.50
Weiss RAL 9010	40/10		9.10	10.50
Blank	40/10		3.90	-.--
Silber eloxiert	40/15		7.00	8.30
Silber eloxiert	50/11		6.90	8.20
Blank	50/11		4.60	-.--
Silber eloxiert	50/15		8.10	9.40
Silber eloxiert	60/11			7.90
Edelstahl eloxiert	60/11	23.10		-.--
Hellbronze eloxiert	60/11	11.50		12.90
Weiss RAL 9003	60/11	10.90		12.30
Weiss RAL 9010	60/11	10.90		12.30
Blank	60/11	5.20		-.--
Silber eloxiert	60/15	9.10		10.40
Silber eloxiert	80/11	11.40		12.80
Silber eloxiert	100/11	14.50		-.--

Detail Preisliste (exkl. MwSt.)

07/22

27/6

Alu-Aussenecken zu Alu-Sockel mit Fuss

Profil	Silber eloxiert Preis/Stk.	hellbronze eloxiert Preis/Stk.	RAL 9003 / 9010 Preis/Stk.
40/10	13.40	14.00	16.20
40/15	18.20	---	---
50/11	14.20	---	---
60/11	15.20	15.70	17.90
60/15	20.40	---	---
80/11	16.20	---	---

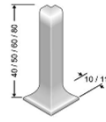

Alu-Innenecken zu Alu-Sockel mit Fuss

Profil	Silber eloxiert Preis/Stk.	hellbronze eloxiert Preis/Stk.	RAL 9003 / 9010 Preis/Stk.
40/10	18.50	19.00	21.90
40/15	25.00	---	---
50/11	19.80	---	---
60/11	20.50	21.00	23.20
60/15	27.20	---	---
80/11	21.50	---	---

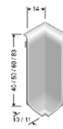

Alu-Endstücke Li / Re zu Alu-Sockel mit Fuss

Profil	Silber eloxiert Preis/Stk.	hellbronze eloxiert Preis/Stk.	RAL 9003 / 9010 Preis/Stk.
40/10	9.90	10.40	12.60
40/15	13.10	---	---
50/11	10.40	---	---
60/11	11.20	11.70	13.90
60/15	14.60	---	---
80/11	11.70	---	---

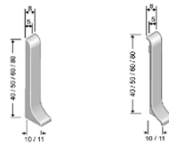

Alu-Verbindungsstücke zu Alu-Sockel mit Fuss

Profil	Silber eloxiert Preis/Stk.	hellbronze eloxiert Preis/Stk.	RAL 9003 / 9010 Preis/Stk.
40/10	11.70	12.20	14.40
40/15	15.60	---	---
50/11	12.70	---	---
60/11	12.40	12.90	15.20
60/15	16.00	---	---
80/11	12.90	---	---

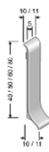

Detail Preisliste (exkl. MwSt.)

07/22

27/7

Alu-Sockel parallel

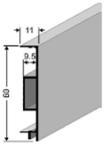
Materialart	Profil		ungelocht Preis/m ¹	gelocht Preis/m ¹
	Standardlänge 4.00 m	6 Stück pro Bund		
Silber eloxiert	40/10		9.00	10.40
Silber eloxiert	50/11		10.10	11.40
Silber eloxiert	60/11		10.40	11.80
Silber eloxiert	80/11		14.70	---
Silber eloxiert	100/12		17.10	---

Alu-Clip Basisprofil passend zu Alu-Sockel parallel

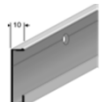
Profil		40 mm Preis/m ¹	50 mm Preis/m ¹	60 mm Preis/m ¹
	Standardlänge 4.00 m	6 Stück pro Bund		
Alu-Clip Basisprofil			5.40	6.30
			6.30	6.90
			6.90	

Dichtungsprofil passend zu allen Alu-Sockel parallel

Profil	Rollenlänge 24 m	Preis/m ¹
Dichtungsprofil	4 Silbergrau	2.50

Alu-Aussenecken zu Alu-Sockel parallel

Profil		Silber eloxiert Preis/Stk.
40/10		14.00
50/11		14.80
60/11		15.70

Alu-Innenecken zu Alu-Sockel parallel

Profil		Silber eloxiert Preis/Stk.
40/10		14.00
50/11		14.80
60/11		15.70

Alu-Endstücke Li/Re zu Alu-Sockel parallel

Profil		Silber eloxiert Preis/Stk.
40/10		10.20
50/11		11.00
60/11		11.80

Alu-Verbindungsstücke zu Alu-Sockel parallel

Profil		Silber eloxiert Preis/Stk.
40/10		12.40
50/11		13.20
60/11		13.80