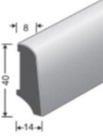

**Detail Preisliste** (exkl. MwSt.)

07/21

27/1

**Öko-Holzsockel furniert**

Holzarten	<b>Profil konisch 40/14/8 mm</b> Standardlänge 4.00 m 10 Stück pro Bund	lackiert Preis/m <sup>1</sup>	geölt Preis/m <sup>1</sup>
Eiche, Buche gedämpft, Buche ungedämpft, Ahorn		<b>3.80</b>	<b>4.80</b>
Nussbaum amerikanisch		<b>4.10</b>	---
weiss deckend RAL 9010 / RAL 9003 / RAL 9016		<b>4.30</b>	---
Auf Bestellung:			
Kirschbaum		4.10	---

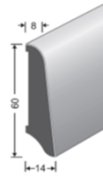
Holzarten	<b>Profil konisch 60/14/8 mm</b> Standardlänge 4.00 m 10 Stück pro Bund	lackiert Preis/m <sup>1</sup>	lackiert Preis/m <sup>1</sup>	geölt Preis/m <sup>1</sup>
		<b>Sonderlänge 2.40 m</b>		
Eiche		3.90	<b>3.90</b>	<b>4.90</b>
Buche gedämpft		3.80	<b>3.80</b>	4.80
Buche ungedämpft, Ahorn		3.80	<b>3.80</b>	---
Nussbaum amerikanisch		4.30	<b>4.30</b>	5.30
Kirschbaum		4.30	<b>4.30</b>	---
Kiefer*, Birke*, Erle*, Kork natur		---	<b>4.30</b>	---
Esche weiss lasiert, Esche crème lasiert*		---	<b>4.60</b>	---
weiss deckend RAL 9010 / RAL 9003 / RAL 9016		4.70	<b>4.70</b>	---
Auf Bestellung:				
Lärche			4.30	---
Esche, Birnbaum/Elsbeer, Ulme (leicht gedämpft)		4.30	---	
Eichen Optik (18 Farbtöne gemäss Musterfächer)		5.80	---	

Holzarten	<b>Profil konisch 70/14/8 mm</b> Standardlänge 4.00 m 10 Stück pro Bund	lackiert Preis/m <sup>1</sup>
Eiche		6.00
Buche gedämpft		5.90
weiss deckend RAL 9003 / RAL 9010 / RAL 9016		6.60
kein Montagezubehör lieferbar!		

Holzarten	<b>Profil konisch 60/22/8 mm</b> Standardlänge 4.00 m 10 Stück pro Bund	lackiert Preis/m <sup>1</sup>
Eiche		<b>5.10</b>
Buche gedämpft, Ahorn		<b>5.00</b>
weiss deckend RAL 9010		<b>5.50</b>

<b>Montagezubehör</b>		Aussenecken Preis/Stk.	Innenecken Preis/Stk.	Endstücke Li / Re Preis/Stk.
Montagezubehör 14/8	* = kein Montagezubehör erhältlich	<b>2.00</b>	<b>2.00</b>	<b>1.65</b>
Montagezubehör 22/8	> Abverkauf, nur solange Vorrat	<b>1.75</b>	<b>1.75</b>	<b>1.45</b>

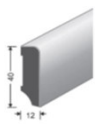
Holzarten	<b>Profil parallel 40/12 mm</b> Standardlänge 4.00 m 10 Stück pro Bund	lackiert Preis/m <sup>1</sup>
Eiche		<b>4.00</b>
weiss deckend RAL 9010 / RAL 9003 / RAL 9016		<b>4.80</b>

Holzarten	<b>Profil parallel 60/12 mm</b> Standardlänge 4.00 m 10 Stück pro Bund	lackiert Preis/m <sup>1</sup>
Eiche		<b>4.20</b>
weiss deckend RAL 9010 / RAL 9003 / RAL 9016		<b>5.20</b>

**Detail Preisliste** (exkl. MwSt.)

07/21

27/2

## Spezialitätensockel furniert

Holzarten	<b>Profil konisch 60/14/8 mm</b> Standardlänge 4.00 m    10 Stück pro Bund	ummantelt Preis/m <sup>1</sup>	lackiert Preis/m <sup>1</sup>
		<b>Sonderlänge 2.50 m</b>	
Aluminium ummantelt		<b>9.30</b>	
Jatoba, Mahagoni			5.80
Aframasia, Akazie gedämpft, Doussie			5.90
Merbau, Wenge			5.90
Bambus hell, Bambus dunkel			7.20
Kork natur			5.90
Kork crème lasiert			7.10

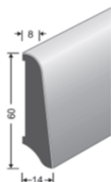

## Kunststoff-Sockel

Dekor	<b>Profil konisch 60/14/8 mm</b> Standardlänge 4.00 m    10 Stück pro Bund	Preis/m <sup>1</sup>
Eiche, Buche gedämpft, Ahorn, Weiss deckend (ähnlich RAL 9010)		<b>3.90</b>
Auf Bestellung:		
Artemis, Dionysos, Eros, Ganymedes, Iris, Megaira, Rhea, Zeus		4.10
Eiche Morpheus (Räuchereiche)		4.50

## Massivholz Sockelleisten

### Sockelleisten Ramin

Holzarten	<b>Profil konisch 60/12/8 mm</b> Längen zwischen 2.50 und 4.00 m    pro Bund zwischen 35 - 45 m <sup>1</sup>	solange Vorrat lackiert Preis/m <sup>1</sup>
Ramin	roh	<b>4.40</b>
Ramin	natur lackiert	<b>4.90</b>
Koto	natur lackiert	9.20
Koto	Eichenton	9.00
Koto	Nusston	10.40
Koto	weiss deckend RAL 9003	12.00
Koto	weiss deckend RAL 9010	12.00
Koto	seidengrau deckend RAL 7044	12.50
Koto	cremeweiss deckend RAL 9001	12.50
Koto	schwarz deckend RAL 9017	12.50

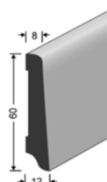

### Sockelleisten massiv

Holzarten	<b>Profil konisch 60/14/8 mm</b> Längen zwischen 2.00 und 4.00 m    pro Bund zwischen 35 - 45 m <sup>1</sup>	lackiert Preis/m <sup>1</sup>	geölt Preis/m <sup>1</sup>
Buche gedämpft		<b>7.00</b>	8.20
Buche ungedämpft		<b>7.00</b>	8.20
Ahorn europäisch		<b>10.10</b>	11.30
Eiche europäisch		<b>11.60</b>	12.80
Esche		7.50	8.70
Fichte		7.00	8.20
Lärche		10.10	--

Holzarten	<b>Profil konisch 80/15/10 mm</b> Längen zwischen 2.50 und 4.00 m    pro Bund zwischen 35 - 45 m <sup>1</sup>	lackiert Preis/m <sup>1</sup>
Buche gedämpft		12.00
Buche ungedämpft		12.40
Ahorn kanadisch		16.90
Eiche europäisch		<b>16.40</b>

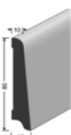

**Detail Preisliste** (exkl. MwSt.)

07/21

27/3

**Schwellenleisten massiv; natur-/farblackiert**

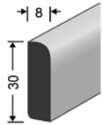
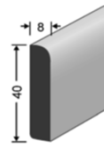
Holzarten	Längen zwischen 2.50 und 4.00 m	pro Bund zwischen 35 - 45 m <sup>1</sup>	solange Vorrat	
			30/8 Preis/m <sup>1</sup>	40/8 Preis/m <sup>1</sup>
Buche gedämpft			<b>3.50</b>	4.50
Buche ungedämpft			<b>3.70</b>	4.70
Eiche			<b>4.50</b>	5.70
Ahorn kanadisch			<b>6.00</b>	7.00
Ramin Weiss deckend	RAL 9003		<b>4.00</b>	
Koto Weiss deckend	RAL 9003		4.20	5.50
Tanne			3.80	---

**Lignoform-Kabelsockel inkl. Grundleiste**

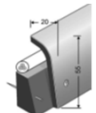
Holzarten	<b>Profil 55/20 mm</b> Standardlänge 4.00 m	8 Stück pro Bund	lackiert Preis/m <sup>1</sup>
Eiche			<b>5.20</b>
Buche gedämpft			5.20
Ahorn kanadisch (solange Vorrat)			<b>6.40</b>
Weiss deckend			<b>6.30</b>



<b>Montagezubehör</b>	Aussenecken Preis/Stk.	Innenecken Preis/Stk.	Endstücke Li / Re Preis/Stk.
Montagezubehör Lignoform-Kabelsockel	<b>2.10</b>	<b>2.10</b>	<b>1.70</b>

**Meister-Sockelleisten**

siehe Meister-Preisliste

**Alu Sockelleisten**

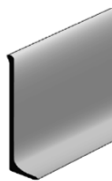
**Alu-Sockel mit Fuss**

Materialart	<b>Profil</b> Standardlänge 4.00 m	6 Stück pro Bund	ungelocht Preis/m <sup>1</sup>	gelocht Preis/m <sup>1</sup>
Silber eloxiert	40/10		5.50	6.80
Hellbronze eloxiert	40/10		9.10	10.40
Weiss RAL 9003	40/10		8.70	10.00
Weiss RAL 9010	40/10		8.70	10.00
Blank	40/10		3.70	---
Silber eloxiert	40/15		6.60	7.90
Silber eloxiert	50/11		6.60	7.80
Blank	50/11		4.40	---
Silber eloxiert	50/15		7.70	9.00
Silber eloxiert	60/11		7.50	8.80
Silber eloxiert selbstkleb.	60/11		12.50	---
Edelstahl eloxiert	60/11		22.00	---
Hellbronze eloxiert	60/11		11.00	12.30
Weiss RAL 9003	60/11		10.40	11.70
Weiss RAL 9010	60/11		10.40	11.70
Blank	60/11		4.90	---
Silber eloxiert	60/15		8.70	10.00
Silber eloxiert	80/11		10.90	12.20
Silber eloxiert	100/11	13.80	---	

**Detail Preisliste** (exkl. MwSt.)

07/21

27/4

**Alu-Aussenecken zu Alu-Sockel mit Fuss**

Profil	Silber eloxiert Preis/Stk.	hellbronze eloxiert Preis/Stk.	RAL 9003 / 9010 Preis/Stk.
40/10	13.00	13.50	15.70
40/15	17.70	---	---
50/11	13.80	---	---
60/11	14.80	15.30	17.40
60/15	19.80	---	---
80/11	15.70	---	---

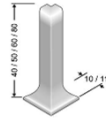

**Alu-Innenecken zu Alu-Sockel mit Fuss**

Profil	Silber eloxiert Preis/Stk.	hellbronze eloxiert Preis/Stk.	RAL 9003 / 9010 Preis/Stk.
40/10	18.00	18.40	21.20
40/15	24.30	---	---
50/11	19.20	---	---
60/11	19.90	20.40	22.60
60/15	26.40	---	---
80/11	20.90	---	---

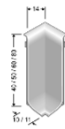

**Alu-Endstücke Li / Re zu Alu-Sockel mit Fuss**

Profil	Silber eloxiert Preis/Stk.	hellbronze eloxiert Preis/Stk.	RAL 9003 / 9010 Preis/Stk.
40/10	9.60	10.10	12.30
40/15	12.80	---	---
50/11	10.10	---	---
60/11	10.80	11.30	13.50
60/15	14.20	---	---
80/11	11.30	---	---

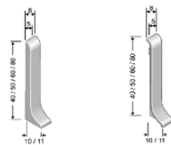

**Alu-Verbindungsstücke zu Alu-Sockel mit Fuss**

Profil	Silber eloxiert Preis/Stk.	hellbronze eloxiert Preis/Stk.	RAL 9003 / 9010 Preis/Stk.
40/10	11.30	11.80	14.00
40/15	15.10	---	---
50/11	12.30	---	---
60/11	12.10	12.60	14.70
60/15	15.60	---	---
80/11	12.60	---	---

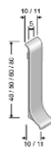

**Detail Preisliste** (exkl. MwSt.)

07/21

27/5

**Alu-Sockel parallel**

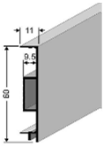
Materialart	Profil		ungelocht Preis/m <sup>1</sup>	gelocht Preis/m <sup>1</sup>
	Standardlänge 4.00 m	6 Stück pro Bund		
Silber eloxiert	40/10		8.60	9.90
Silber eloxiert	50/11		9.90	11.20
Silber eloxiert	60/11		9.70	11.00
Silber eloxiert	80/11		14.00	---
Silber eloxiert	100/12		16.30	---

**Alu-Clip Basisprofil passend zu Alu-Sockel parallel**

Profil		40 mm Preis/m <sup>1</sup>	50 mm Preis/m <sup>1</sup>	60 mm Preis/m <sup>1</sup>
	Standardlänge 4.00 m	6 Stück pro Bund		
Alu-Clip Basisprofil			5.10	6.00
			6.00	6.50

**Dichtungsprofil passend zu allen Alu-Sockel parallel**

Profil	Rollenlänge 24 m	Preis/m <sup>1</sup>
Dichtungsprofil	4 Silbergrau	2.40

**Alu-Aussenecken zu Alu-Sockel parallel**

Profil		Silber eloxiert Preis/Stk.
40/10		13.60
50/11		14.40
60/11		15.20

**Alu-Innenecken zu Alu-Sockel parallel**

Profil		Silber eloxiert Preis/Stk.
40/10		13.60
50/11		14.40
60/11		15.20

**Alu-Endstücke Li/Re zu Alu-Sockel parallel**

Profil		Silber eloxiert Preis/Stk.
40/10		9.90
50/11		10.70
60/11		11.50

**Alu-Verbindungsstücke zu Alu-Sockel parallel**

Profil		Silber eloxiert Preis/Stk.
40/10		12.00
50/11		12.80
60/11		13.40